

PURE

Pure Brassware



PRODUCT DETAILS:







- Pure is a highly dynamic collection of brass taps, showers and accessories that typify contemporary minimalism.
- Using the same attention to craftsmanship that is embedded in our tradition of excellence, a refined route of manufacturing processes allows for the use of fewer metal parts to conserve precious metals and reduce our factory's consumption of energy. In turn, this means that Pure is more environmentally friendly.

PRODUCT INFORMATION

BATHROOMS

FIRED EARTH

FINISH OPTIONS:

			
Chrome (CP)	Polished Nickel	Antique Gold (AG)	Brushed Nickel (SSF)
			
Brushed Gold Matt (BGM)	Antique Brass Matt (ABG)	Vintage Bronze (CTB)	

PRODUCT CODE:

PUREMONOCTL

Pure Monobloc Basin Mixer (waste not included) – Speed Lever



TECHNICAL DRAWING:

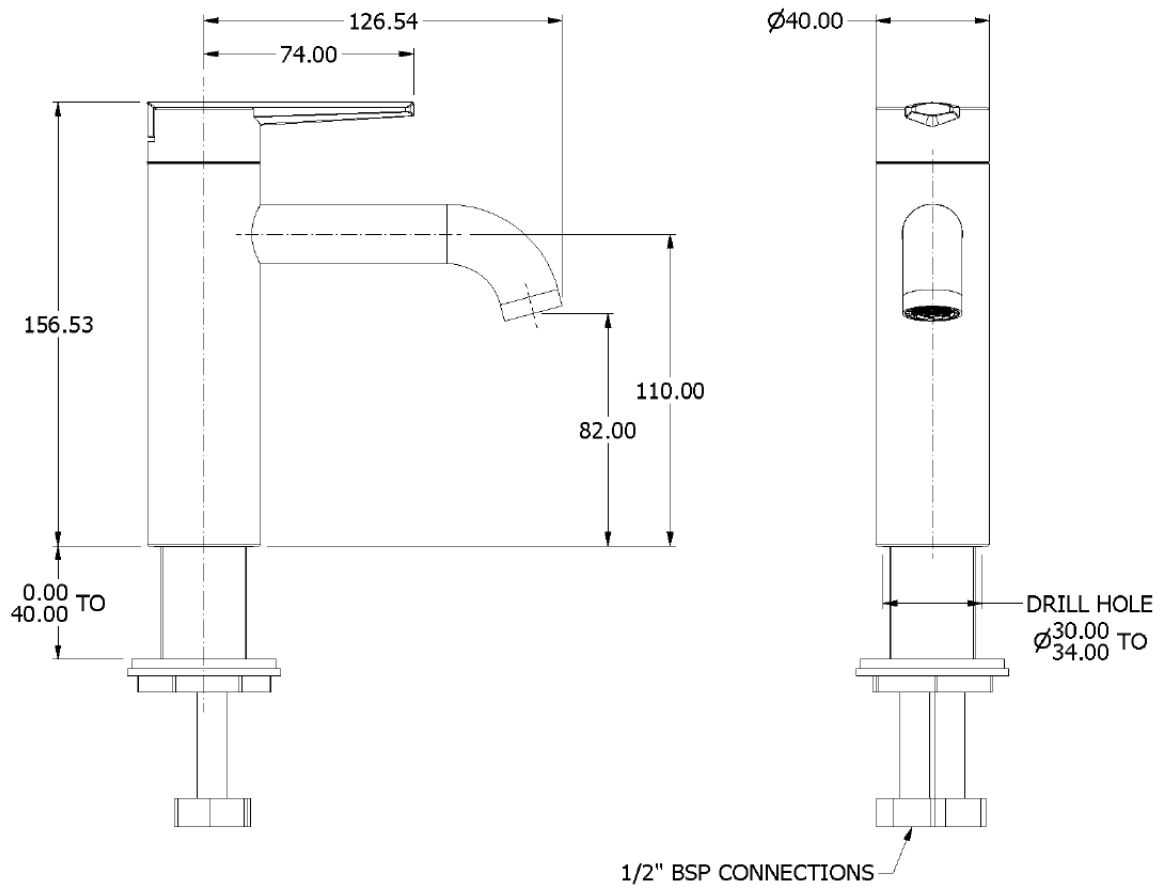

TECHNICAL INFORMATION:

Materials	Brass
Certifications?	WRAS approved product
Plumbing information	1/2" BSP Connections

FLOW RATES:

0.5 bar	1.7 L/min
1.0 bar	2.5 L/min
2.0 bar	3.8 L/min
3.0 bar	4.00 L/min
4.0 bar	4.00 L/min
5.0 bar	4.00 L/min

CARE & MAINTENANCE:

Daily care for all finishes: The best way to maintain the looks and workings of your taps and shower fittings is to clean them on a regular basis. This prevents the build-up of dirt and limescale. For best results, after each use:

- Rinse with water or wipe with a clean, damp cloth, taking care to remove any toothpaste or soap residue.
- Gently dry with a clean micro-fibre cloth

For a more thorough clean use a weak solution of mild liquid soap and warm water, rinse well, then gently dry with a clean micro-fibre cloth

Avoid: Many bathrooms and household cleaning solutions contain chemicals that are damaging to surface finishes. It is best to avoid them and instead follow the cleaning guidelines above. Damage caused by bathroom or household cleaners is not covered by the guarantee.

Shower heads: Deluges and Hand Showers are best cleaned on a regular basis as limescale build up may impede their effectiveness. Heads with rubber nozzles are easy to keep clean by gently running fingers across the nozzles to loosen limescale deposits, then cleaning them away with a damp cloth.

We hope you are fully satisfied with your Fired Earth products, however in the unlikely event that the product is unsuitable or that you are not fully satisfied please refer to our full terms and conditions - <https://www.firedearth.com/returns-refunds>