

Malia Freestanding Acrylic Bath

Product Code: MALBAT1700 – Malia bath including chrome clicker waste

Features and Benefits

- Max Dimensions: 1700 x 583 x 820mm
- Double-ended freestanding bath manufactured from Lucite acrylic to give a high gloss finish
- Lucite is lighter stone resin and warmer to the touch than stainless steel.
- Slimline 20mm profile edge and polished curves create an elegant contemporary design
- Features stainless steel slot overflow and unobtrusive recessed waste
- Lifetime guarantee against manufacturing faults
- Made in Europe
- UV stable and colourfast, no discoloration with age or direct sunlight

FAQ's

Q Is it easy to install?

A Yes, however we always recommend our fittings are installed by a professional installer

Q How thick are the walls of the bath?

A Each skin is made from 4mm Lucite acrylic, giving an overall 20mm profile edge.

Q What is the weight of the bath when empty?

A 51Kgs

Q What is the normal water capacity of the bath?

A 276lts. 206ltrs allowing for average 70 kilo person

Q What is the weight of the bath when full of water?

A 327Kgs. NB: It is unusual to completely fill a bath with water, please bear in mind that a person will displace approximately one litre of water for each kilo they weigh.

Q What characteristics are normal to these Acrylic baths?

A The bath material absorbs the ambient temperature of the room so it is warm to the touch and you can enjoy a longer bathing experience.

Product Information

Analysis code 1: BAML

Available from: April 2015

Ordering process: Special order item. Check PU for current lead time.

The up to date version (controlled document) is on the Fired Earth intranet. Always check any printed version before use.

Malia Freestanding Acrylic Bath

Dimensional Drawing

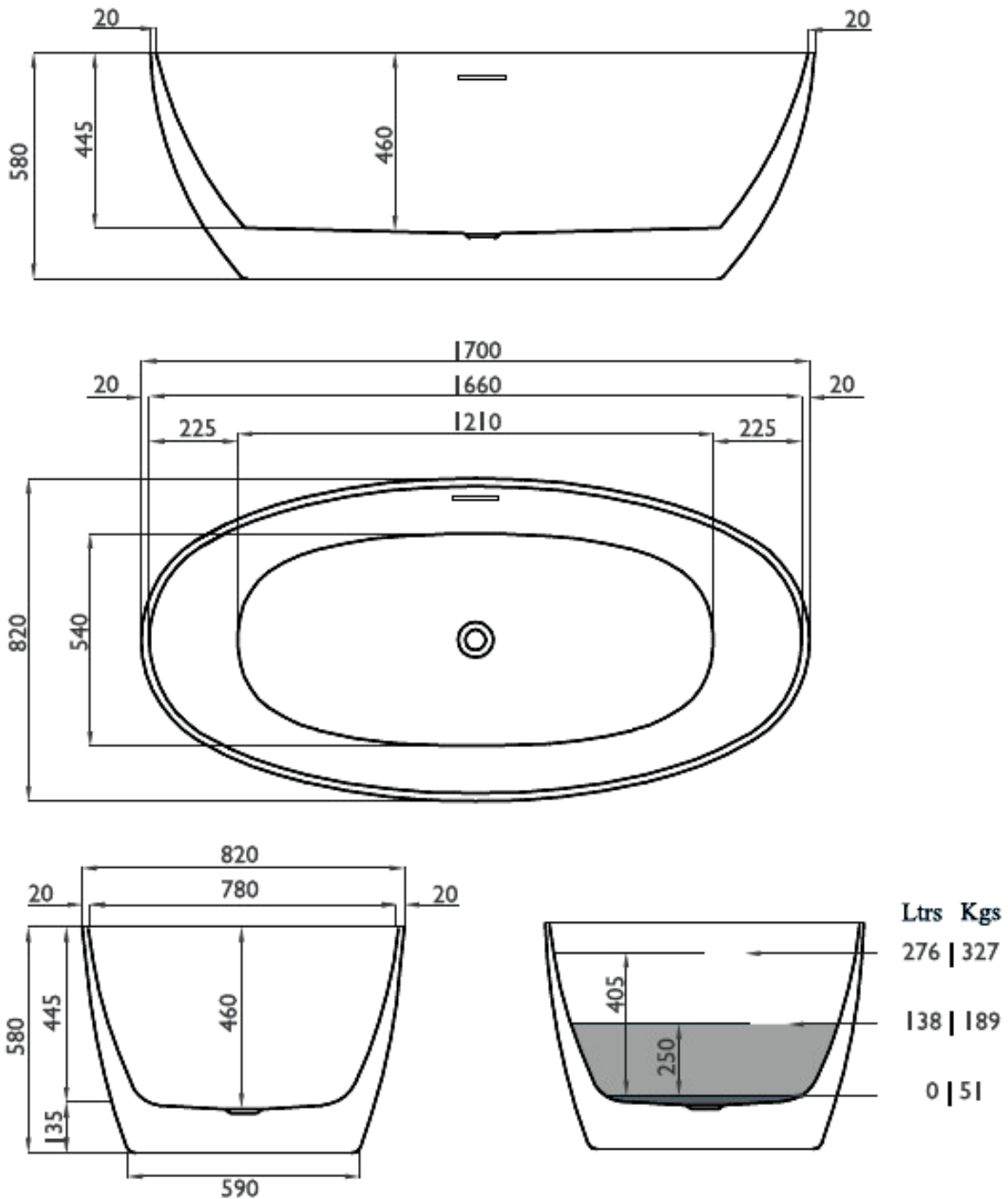

Pack Contents

	Description	Qty
1.	Bath	1
2.	Waste kit – delivered in bath	1

The up to date version (controlled document) is on the Fired Earth intranet. Always check any printed version before use.

Malia Freestanding Acrylic Bath

Installation Instructions

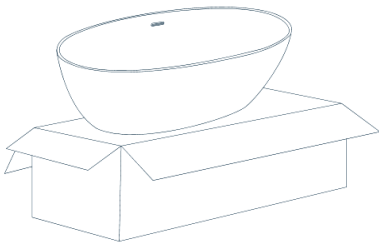

Carefully open the box at the top, cutting the banding and taped seam. Do not insert a blade through the cardboard as this may damage the bath inside. Remove the top cardboard sheet and corner inserts. Leaving the bath fully wrapped remove from the carton. Carefully unwrap all the shrink wrap and foam protection from around the bath. Remove all packaging from the working area although you may find a cardboard sheet useful as installation template. Leave the internal cellophane sheet inside the bath until installation is complete to avoid any accidental damage.

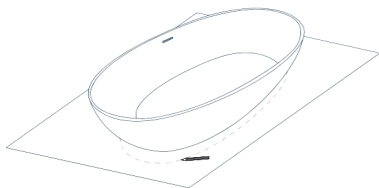

Once unwrapped, carefully check the bath to ensure it is perfect condition before undertaking installation. Locate the bath in its intended position and draw around the lower outer edge and mark the waste location with a pencil. Access to the waste and any isolation valves should be considered.

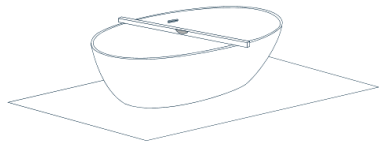

With the bath in its intended position use a large spirit level to check that it is level on both the horizontal and vertical plains. The bath can be adjusted by twisting the four threaded feet. Only if the bath is level will all the water drain to the waste outlet. Ensure the bath stands evenly at least 1-2mm off the floor to allow for expansion and to create a positive fixing seal. Once the bath is level, tighten the foot adjustment lock-nuts to ensure no further movement. Ensure you allow for any variation of the floor surface and that the bath has been levelled in its intended final location.

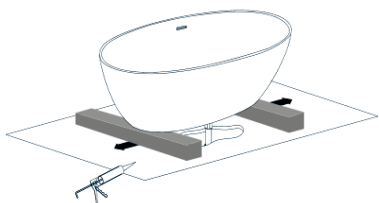
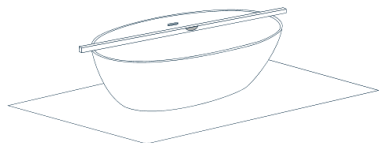

In most instances the waste will have to be recessed into the floor and connected using a flexible fitting. Once the pipe work is completed and ready to receive the bath we recommend raising the bath on a number of blocks – this will allow working access for you to connect the waste to the underside of the bath. Once tight add silicone adhesive to the base of each foot, remove the blocks and lower the bath into position, ensuring that the pipe work is not damaged.



Before final fixing check that the bath is level and connected to the plumbing system, by adding water and ensuring it drains away adequately leaving no puddles and that there are no leaks. Once checked, half fill the bath to ballast it before securing it to the floor. Apply silicone adhesive evenly between the base of the bath and the floor filling the 1-2mm gap.

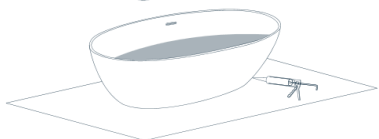

To ensure the best result leave the water in the bath 10 – 12 hours or overnight while the silicone adhesive sets.



10-12 Hours

Malia Freestanding Acrylic Bath

Care & Maintenance

To clean your bath use a soft damp cloth and warm soapy water, household bathroom cleaners may also be used – but you should check their suitability before proceeding. Do not use abrasive scrubbing materials or harsh chemical cleaners as these may permanently damage the bath's surface and finish. If you do scratch your bath, we recommend using an enamel cleaning agent or car polish (T-Cut), this will help to restore your bath back to a lustre finish.

Warning

Solvents such as paint stripper or nail varnish remover will damage the bath.

A leaking or dripping tap may cause localized damage and dis-colouration. We recommend that taps are repaired promptly to avoid such damage.

PRODUCT INFORMATION

FIRED EARTH

Malia Freestanding Acrylic Bath

Warehouse Information

Net Weight:	51kg														
Gross Weight:	63kg														
No of boxes per product code:	1														
Dimensions of outers:	n/a														
How many inners per outer:	n/a														
Dimensions of inner:	n/a														
Agreed packaging standard:	Bath crate														
Label specification: (Inc FE code, weight and PO ref)	<table border="1"><tr><td colspan="2" style="text-align: center;">FIRED EARTH</td></tr><tr><td>FE PRODUCT CODE</td><td>MALBAT1700</td></tr><tr><td>FE DESCRIPTION</td><td>Malia Bath inc waste</td></tr><tr><td>SUPPLIER DESCRIPTION</td><td>Stream</td></tr><tr><td>QTY OF PIECES PER BOX</td><td>1</td></tr><tr><td>FE PURCHASE ORDER</td><td></td></tr><tr><td>GROSS WEIGHT / KG</td><td>63</td></tr></table>	FIRED EARTH		FE PRODUCT CODE	MALBAT1700	FE DESCRIPTION	Malia Bath inc waste	SUPPLIER DESCRIPTION	Stream	QTY OF PIECES PER BOX	1	FE PURCHASE ORDER		GROSS WEIGHT / KG	63
FIRED EARTH															
FE PRODUCT CODE	MALBAT1700														
FE DESCRIPTION	Malia Bath inc waste														
SUPPLIER DESCRIPTION	Stream														
QTY OF PIECES PER BOX	1														
FE PURCHASE ORDER															
GROSS WEIGHT / KG	63														

The up to date version (controlled document) is on the Fired Earth intranet. Always check any printed version before use.